

? Notice:

1. After receiving the light, please unpack and check whether there is damage caused during transportation; if there is damage caused during transportation, please do not use, and contact the dealer or manufacture as soon as possible.
2. When connecting the wire joint, please pay attention to the contact points marked by the joint.
3. Please pay attention to moisture-proof during storage.
4. Do not use the fixture in any environment above 45 Celsius degree.
5. Do not use or store the light near any high temperature object.

? General Breakdown checking:

Measurement	Description of Breakdown
The light cannot start up normally:	<ol style="list-style-type: none"> a) Check whether the adapter is normal and ensure the voltage is correct. b) Check whether the adapter is loosened with the light c) Check whether the display screen is on, if it is on, check whether the brightness is zero or is in the "Storm" lightning mode.
The light has an abnormal flicker:	<ol style="list-style-type: none"> a) Check whether the adaptor is well connected, and with sufficient output power. b) Please check if it is near any high temperature object and make the operational environment temperature too high. c) The light can illuminate normally, but it is out of control: check whether the lighting address code is correct.

▲Note: The questions mentioned here is not certainly caused by the breakdown, please check the lighting again before contact the distributor and manufacturer, eliminate the following problems before send the light for repair.

Guangdong NanGuang Photo&Video Systems Co.,Ltd

Add: Zhanglin Section, Highway 324, Dongli, Chenghai, Shantou City, Guangdong Province, China
 Tel: +86-754-85751187 Fax: +86-754-85300887
 E-mail: service@nglbg.com http://www.nanguang.cn

TRGB1212B LED Tube Light

Instruction Sheet

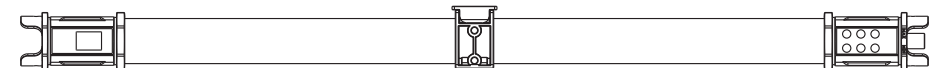

◆ Extra Parameters:

CCT : 2700K-6500K	CRI(Ra) : 95
LED lamps amount: 800pcs	Output : 32W×5
Voltage : 15VDC=4A	ta=45°C
Lithium Battery: 14.8V/2200mAh, 32.5Wh×2	

www.nanguang.cn

• The package consists of the following parts, please kindly check.

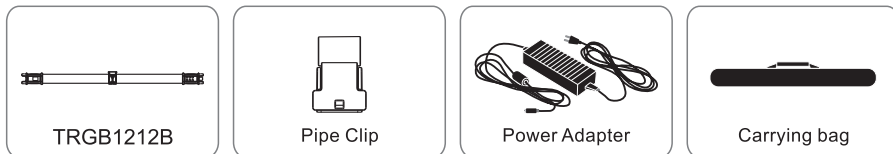

Components:

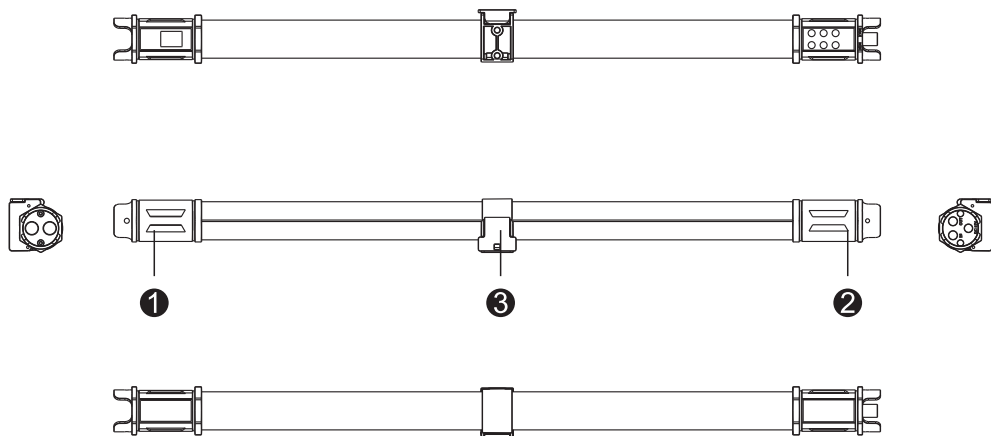

- ① .Left cover: there is a power socket; synchronous sockets as well as a power switch on it.
- ② .Right cover: there are six function buttons, dimming knob and multi-functional knob on it.
- ③ .Clamp: this is for fixing the lamp tube with two 1/4 screw holes, and can be directly mounted on the light stand or can be fixed on the accessories such as hotshoe before it will be mounted on the light stand.

Instructions:

1.Can be placed directly on the plane.
Upward in 90°as Pic 1.



Upward in 60°as Pic 2.



Downward in 30°as Pic 3.

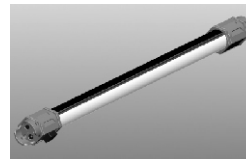

Downward in 0°as Pic 4.



Could Hoist the light tube with the wire-rope on the left and right caps (the max load is 20KG)
Parallel lifting as Pic 1 Hoist in series as Pic 2

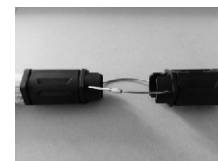

- Also could mount the light tube on the light stand with the clamp.
- 2.After mounting the light, choose the way of power support, it can use the built in battery or the AC adapter to supply the power.
 - 3.Turn on the switch and press "MENU" to Level 1 Menu according to your demands, and choose "CCT" or "HSI" from the menu or press "CCT" or "HSI" directly to call up the function.
 - 4.Adjust the "Multi-functional knob" and "Dimmer" to adjust the light to the best state.
 - 5.If you need special effects, you can press the "Special effect" or "Cycle" to select the required functions, or you can enter the first level menu through the MENU button, and then select the required functions according to the relationship between the above menu trees.
 - 6.If you need control lights by wireless remote, you can check or adjust the address code of lighting through the "MENU button" and select the "5 Address" option under the Level 1 Menu, and then control the corresponding lighting through the corresponding address code.
 - 7.If you need synchronous control of multiple lights, lights can be connected with a synchronous control line, and then press "MENU" button, then select a menu under the "6.Combine Control" menu in the "1 Master" option, select one of the light as master, back to other display menu, there is (M) showed in the right corner. At this point, the user can operate the master light to synchronous control of other lighting fixture.
(▲Note: this function can control 10pcs lighting fixtures at a time)
 - 8.Turn off power switch and finish using.

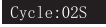
4]. User Define means user could set the cycle period  .

5]. Address option is for setting Fixture wireless control address code  .
 • (Note: Multi-functional knob adjusts address code from 001~100, dimmer adjust brightness.)

6]. Combine Control is the Level 2 Menu for Master-slaver mode  .

- 1]. Master option is master mode.
- 2]. Slaver option is slaver mode.

• (Notes: Use Multi-functional knob to select and enter "MENU" to confirm combine control)

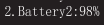
7]. Battery: The option of the battery power  (AC power supply is without this option)

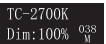
8]. CCT: Press it to enter the "CCT" mode  .

9]. HSI Press it to enter the "HIS" mode  .

10]. ENTER: Confirm to enter the selected option.

11]. RGB CYCLE: Press it to enter the RGB CYCLE mode, press it successively to change the modes.

CYCLE MODE1:  The cycle period is 12s.

CYCLE MODE2:  The cycle period is 4s.

CYCLE MODE3:  The users can set the cycle period from 2s to 16s flexibly.

Cycle OFF: use to turn off the cycle mode  .

• (Note: When in CYCLE MODE1 and CYCLE MODE2, Multi-functional knob is used to adjust the Saturation; It is used to adjust the cycle period when in CYCLE MODE3; Dimmer knob is used to adjust the brightness.)

12]. SPECIAL: Press to enter the special effect, press it successively to change the modes.

 COPCAR MODE

 CANDELA MODE

 FLASH TERM OF 1/4s

 FLASH TERM OF 1s

 FLASH TERM OF user-defined

 SOS MODE

 STORM MODE1

 STORM MODE2

 Press to turn off the special effect

• (Note: Multi-functional knob is used to adjusted the brightness when in the copcar mode; Under the candela mode, Multi-functional knob is used to adjust the brightness when in "DIM", it is used to change the speed when in "SPD", it is used to change the color when in "MODE"; Multi-functional knob is used to adjust the color temperature when in FLASH TERM OF 1/4s, FLASH TERM OF 1s, SOS MODE; It is used to adjust the brightness when in FLASH TERM OF user-defined from 0100ms to 6000ms; Dimmer knob is used to adjust the brightness.)

Instructions:

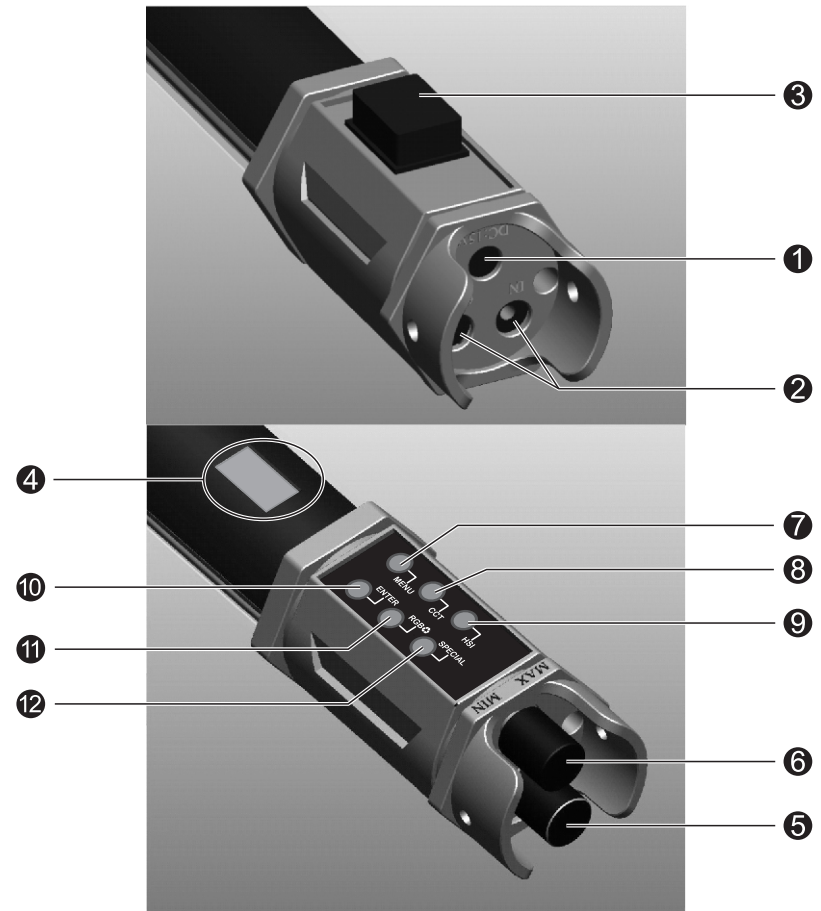

- 1]. DC:15V power input
- 2]. Synchronous input and output interface
- 3]. Power switch
- 4]. Display screen: this shows brightness, color temperature, 2.4G address codes, colors, color change cycle, flashing frequency, degree of saturation, three levels of function menu and other data.

▲ Notes: the higher the saturation is, the stronger the color will be, the lower the saturation is, the lower the light color will be. For example, SAT100: the strongest color, SAT0: the lightest color.)

- 5).Dimmer:this enables you to adjust the brightness,the lighting colors as well as other functions.
- 6).Multi-functional knob:you can choose menu options,adjust color temperature or lighting saturation among other functions.
- 7).MENU pressing button:pop up the MENU interface.
 - Notes:You can simply switch to the menu at any mode

▼ **Level 1 MENU**

MENU
1. CCT
2. HSI
*3. Special Effect
4. Cycle
5. Address
6. Combine Control
7. Battery

▼ **Level 2 MENU**

CCT:
TC:2700K
Dim:100%
038 M

HSI:
HSI:236 SAT:095%
DIM:068%
038 M

Special Effect:
1. OFF
2. Storm
*3. Cop Car
4. Candle Light
5. 250ms
6. 1000ms
7. SOS
8. User Define

Cycle:
1. OFF
*2. 12S
3. 4S
4. User Define
SAT:100%

Address
ADDR:078

Combine Control:
1. Master
2. Slave

Battery
1. Battery1:96%
2. Battery2:98%

▼ **Level 3 MENU**

Storm:
<--
*1. Storm:1
2. Storm:2

Cop Car:
<--
1. Single
2. Double
*3. Quint All
4. Quint
5. Quad
6. Cycle

Candle Light:
<--
1. DIM:020
*2. SPD:085
3. MODE:Warm

User Define
<--
TIM:6000ms
DIM:100

User Define
<--
Cycle:02S
DIM:100

(Note:Choose Menu Options via Multi-functional knob, press ENTER button to confirm)

▲(Note: the above menu interface shows only two lines.If there are multiple rows,only two lines next to the * selected option will be displayed,such as *4. Cycle, *5. Address, the multi-functional knobs should be adjusted to scroll the interface and select options.)

1).CCT option ,multi-functional knob adjust color temperature, the dimmer knob adjust brightness.

• (Notes: Above in the picture the "038" means the address code of the lamp, and M is the Master mode. These two parameters need to enter the "Address" interface and "Combine Control" interface to adjust; same in the following other interfaces.)

2).HSI option ,the multi-functional knob enables you to select color, saturation and brightness etc. The dimmer adjusts the parameters of the highlighted articles.

3).Special Effect option is the **Level 2 Menu** option.

1].The OFF option is to close the special effects.

2].Select Storm option and enter to the **Level 3 MENU**.

1).<- option is to return back to **Level 2 Menu**.

2).Storm: 1 option for Storm mode 1.

3).Storm: 2 option for Storm mode 2.

• (Notes: The fixture goes out under the Storm mode. After selecting Storm 1 or 2, press "ENTER" to trigger the Storm, which can be continuously triggered by continuously pressing. Multi-functional knob adjust options, dimming knob adjust brightness.)

3].Select Cop car option and enter to the **Level 3 MENU**.

1).<- option is to return back to **Level 2 Menu**.

2).Single option means red light and blue light alternate each other 1 time in 1 cycle.

3).Double option means red light and blue light alternate each other 2 times in 1 cycle.

4).Quant ALL option means red light and blue light flash 3 times together in 1 cycle.

5).Quad option means red light and blue light alternate each 4 times in 1 cycle.

6).Cycle option means the first 5 modes auto cycle.

• (Notes: Multi-functional knob adjusts options, dimmer adjust brightness.)

4].Select Candle light option and enter to the **Level 3 MENU**.

1).<- option is to return back to **Level 2 Menu**.

2).DIM option adjust the brightness of the candle light.

3).SPD option adjust the change rate of the candle light.

4).MODE option adjusts the candle light color.

• (Note: Multi-functional knob adjusts options, dimmer adjust parameters.)

5).250ms means flashing in 1/4s frequency.

• (Note: The Multi-functional knob adjusts options while dimmer adjusts brightness.)

6).1000ms means flashing in 1s frequency.

• (Note: Multi-functional knob adjusts options, dimmer adjust brightness.)

7).SOS options means flashing in SOS mode.

• (Note: Multi-functional knob adjusts options, dimmer adjust brightness)

8).User Define means user could set the flash frequency .

• (Note: Multi-functional knob adjusts options, dimmer adjust change rate.)

4].Cycle option is the **Level 2 Menu** option.

1].OFF option to close the cycle.

2].12S option means 12S cycle period.

• (Note: Multi-functional knob adjusts options, dimmer adjust brightness.)

3].4S option means 4S cycle period.

• (Note: Multi-functional knob adjusts options, dimmer adjust brightness.)